

A1110-16-E

4-quadrant voltage and current amplifier

DC – 1 MHz | 100 V/ μ s | 1000 W (source) | 340 W (sink)

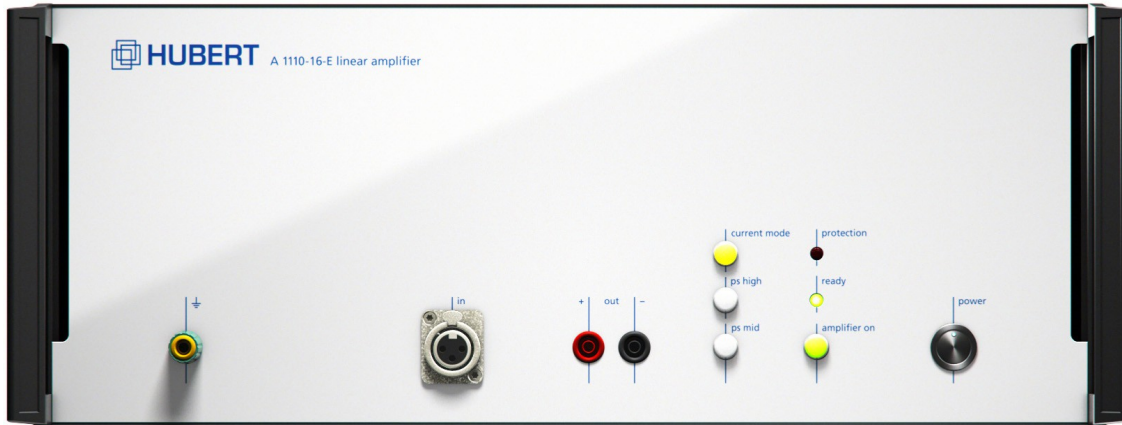

DATA SHEET

The A1110-16-E is a linear, extreme broadband precision power amplifier. It is ideally suited for applications that require fast signal processing at high power.

The A1110-16-E can be operated either as voltage amplifier or as current amplifier. In current amplifier mode it provides constant, frequency-independent output current e.g. for inductive loads.

There are three operating voltages available for optional selection: high-voltage / low-current or low-volt / high-current. Particularly with low impedance load the operating voltage can be reduced to 1/3 of the value, which entails a corresponding reduction of dissipation power.

Output voltage and output current can be optionally limited.

Moreover, low impedance signal outputs are available as monitoring outputs.

The device is equipped with a low-noise, temperature-controlled fan. In addition to over temperature shut-down, a feature for dissipation power calculation and current monitoring ensures perfect overload and short-circuit protection.

An interlock ensures optional operation as remote-controlled safety system.

Operation is performed via the control elements on the front panel of the amplifier and the graphical user interface on a PC, which is connected to the amplifier by means of the USB interface (the required software is included in the scope of delivery).

If higher output voltages or higher output currents are needed, configurations with several A1110-16-E devices connected in series or in parallel are possible.

Features

- 4-quadrant voltage and current amplifier
- Fully configurable and operable by means of the supplied software
- Output voltage max. $75 V_{\text{peak}}$
- Output current max. $28 A_{\text{peak}}$
- Output current $55 A_{\text{peak}} / 500 \text{ ms}$
- Symmetrical input
- Series / parallel input connection in case of higher voltage / current requirements
- USB port as standard (LAN interface optional)
- 3 supply voltages
- Interlock
- Voltage / current monitor output
- 6 configurable compensation networks for inductive loads in current amplifier mode

Software

The scope of delivery includes an application software that ensures fully remote-controlled operation and comprehensive configuration of the amplifier via the USB interface. In this context, disclosure of the line commands guarantee trouble-free integration of existing automated test systems.

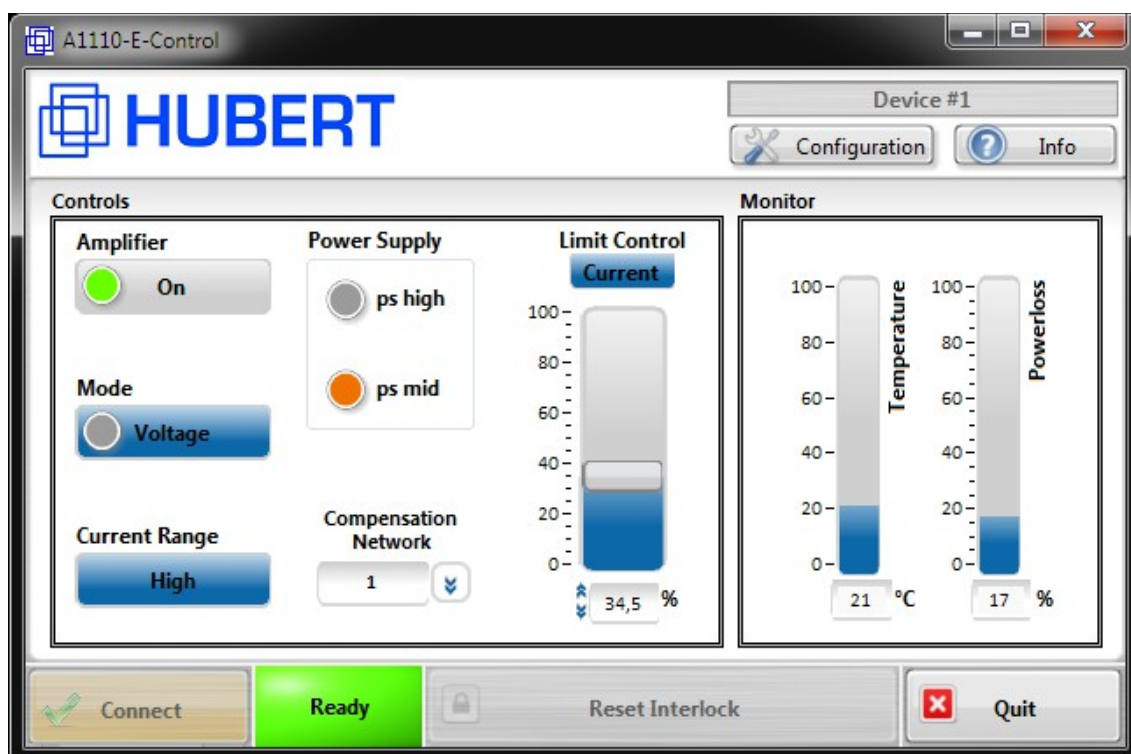

Applications

- General lab applications for research, development and testing
- EMC testing
- Material testing
- MRI
- Component tests
- Plunger coil drives
- Piezo actuation
- Generation of magnetic fields (e.g. with Helmholtz coils)
- Medical engineering
- Laser technology
- Plasma technology

Rear of the amplifier (LAN interface is optional)

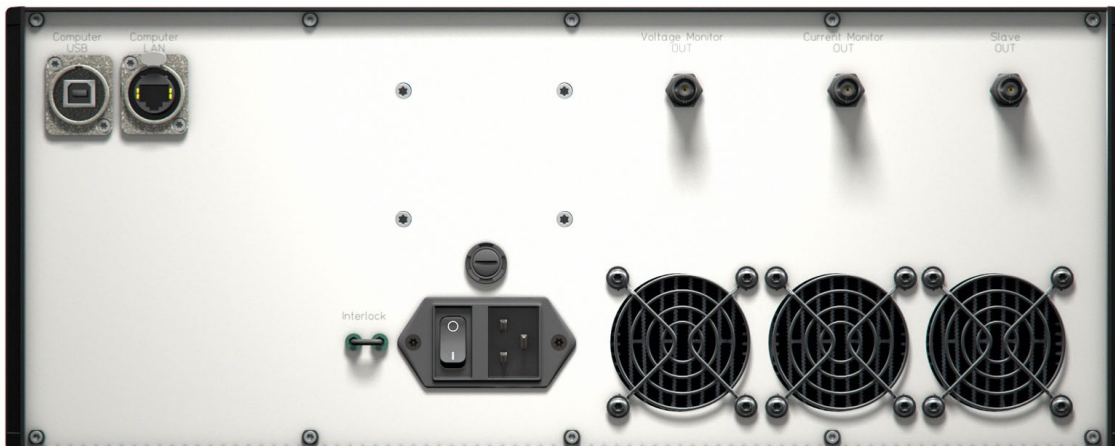

Specifications

Parameters	Specification	Conditions/Moments
	Controlled Voltage Mode	25° C ambient temperature Continuous operation
Input Impedance	100 kOhm 200 kOhm	unbalanced, 1kHz balanced, 1kHz
Maximum Input Level	5.5 V (+14,5 dBV)	< 1 % THD, 1 kHz, 8 Ohm Load
Common-Mode Rejection Ratio	> 60 dB	Rs= 50 Ohm, 10 Hz – 200 kHz, re +34.5 dBV @ Output
Small Signal Frequency Response	DC - 200 kHz DC - 1 MHz	+0, -0.5 dB, 1 W @ 8 Ohm High Voltage Mode +0, -3.0 dB, 1 W @ 8 Ohm High Voltage Mode
Phase response	+0, -5 degrees	10 Hz - 30 kHz
Power Response (continuous)		
8 Ohm Load	400 W 200 W	DC - 100 kHz, < 0.2% THD High Voltage Mode DC – 200 kHz, < 1% THD High Voltage Mode
3 Ohm Load	1000 W 800 W 450 W	DC - 30 kHz, < 0.2% THD High Voltage Mode DC - 100 kHz, < 0.5% THD High Voltage Mode DC - 200 kHz, < 1% THD High Voltage Mode
1 Ohm Load	350 W	DC – 200 kHz, < 0.5% THD Mid Voltage Mode
0.5 Ohm Load	175 W	DC – 200 kHz, < 0.5% THD Low Voltage Mode
Slew Rate	100 V/uSec	
Residual Noise		
10 Hz - 22 kHz	< 100 uV (< -80 dBV)	All Voltage Modes Input shorted 8 Ohm Load
10 Hz - 80 kHz	< 125.5 uV (< -78 dBV)	All Voltage Modes Input shorted 8 Ohm Load
10 Hz - 200 kHz	< 158.5 uV (< -76 dBV)	All Voltage Modes Input shorted 8 Ohm Load
Signal-to-Noise Ratio		
10 Hz - 22 kHz	< -114.5 dB	re +34.5 dBV, < 1% THD 8 Ohm Load High Voltage Mode
10 Hz - 80 kHz	< -112.5 dB	re +34.5 dBV, < 1% THD 8 Ohm Load High Voltage Mode

Parameters	Specification	Conditions/Moments
10 Hz – 200 kHz	< -110.5 dB	re +34.5 dBV, < 1% THD 8 Ohm Load High Voltage Mode
THD+N		
10 Hz – 100 kHz All Voltage Modes	< 0.03 %	1 W @ 8 Ohm
Output Offset	< 1.0 mV	DC
Output Impedance	< 60 mOhm	@1 kHz; Instrument: HP8751A, Network Analyzer
Power, Pulse, 40ms, 20% Duty Cycle		
Peak output		
3.1 Ohm	80 V, 25.8 A	High Voltage Mode
0.25 Ohm	7 V, 28 A	Low Voltage Mode
Current, Pulse, 500ms, 5% Duty Cycle, unipolar		
Peak Output		
60 mOhm	+ 55 A	+Umid / -Ulow
60 mOhm	- 55 A	+Ulow / -Umid
Power, Sinus, 100Hz, continuous		
3 Ohm	55.5 V, 18.5 A, 1026 W	< 1 % THD, High Voltage Mode < 0.5% THD
0.25 Ohm	4.75 V, 19 A, 90 W	Low Voltage Mode
Power, DC		
3 Ohm	45 V, 15 A, 675 W	Mid Voltage Mode
0.55 Ohm	13.5 V, 24.5 A, 330 W	Low Voltage Mode
Sink Power, DC	340 W	Low Voltage Mode; see U/I-Plot
Voltage Monitor	$\pm 100 \text{ mV} \triangleq 1 \text{ V} \pm 2\%$	
Current Monitor	High Current Range: $\pm 200 \text{ mV} \triangleq 1 \text{ A} \pm 2.5\%$ Low Current Range: $\pm 1.2 \text{ V} \triangleq 100 \text{ mA} \pm 1\%$	Shunt = 20 mOhm Shunt = 2.5 Ohm
Gain		
Controlled Voltage Mode	1 V / 10 V	Uin / Uout
Controlled Current Mode	High Current Range: 1 V / 3 A Low Current Range: n.a.	Uin / Iout unspecified
Physical Characteristics		
AC Power	230 VAC / 50 Hz	
Remote control	USB	
Operating Temperature	Ethernet (Option)	
Humidity	10 °C to 55 °C	
	80% or less	non-condensing

Parameters	Specification	Conditions/Moments
Cooling	Forced air	
Dimensions (W x H x D)	449 x 177 x 585.5 mm	
Weight	Approx. 30 kg	

The E series amplifiers are suitable for operation at three different operating voltages:

- high operating voltage (± 90 V) for high output voltages and low load currents
- medium operating voltage (± 60 V) for medium output voltages and medium load currents
- low operating voltage (± 30 V) for low output voltages and high load currents

To keep the dissipation power of the amplifier at a minimum the operating voltage should always be selected corresponding to the load.

Output Voltage vs. Frequency (THD + N < 1%)
 Red: @ 8 Ohm
 Blue: @ 4 Ohm
 Green: @ 2 Ohm

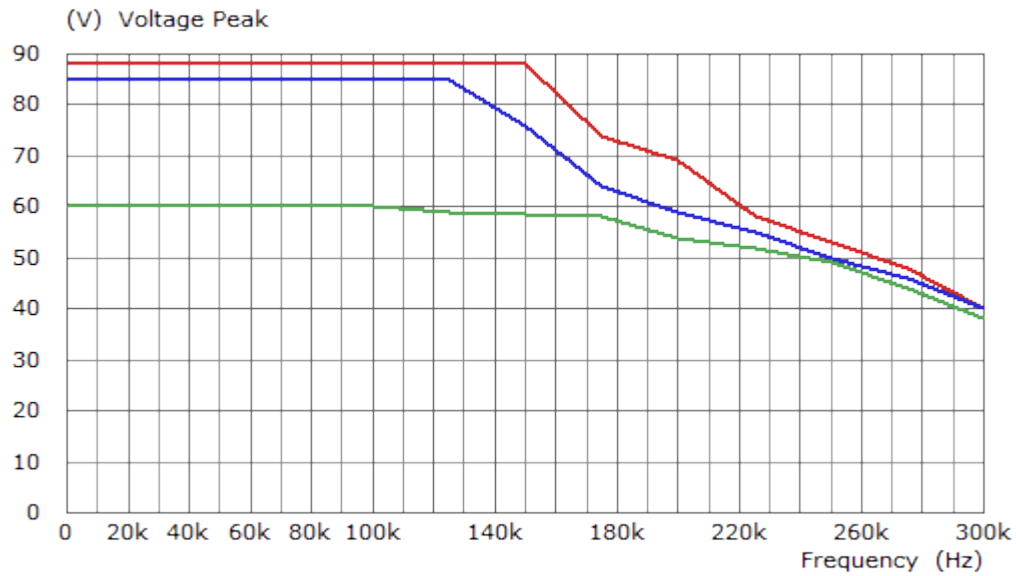

Output Current vs. Output Voltage (THD + N < 1%)
 Supply Voltage: Low
 Blue: AC Limit
 Red: DC Limit

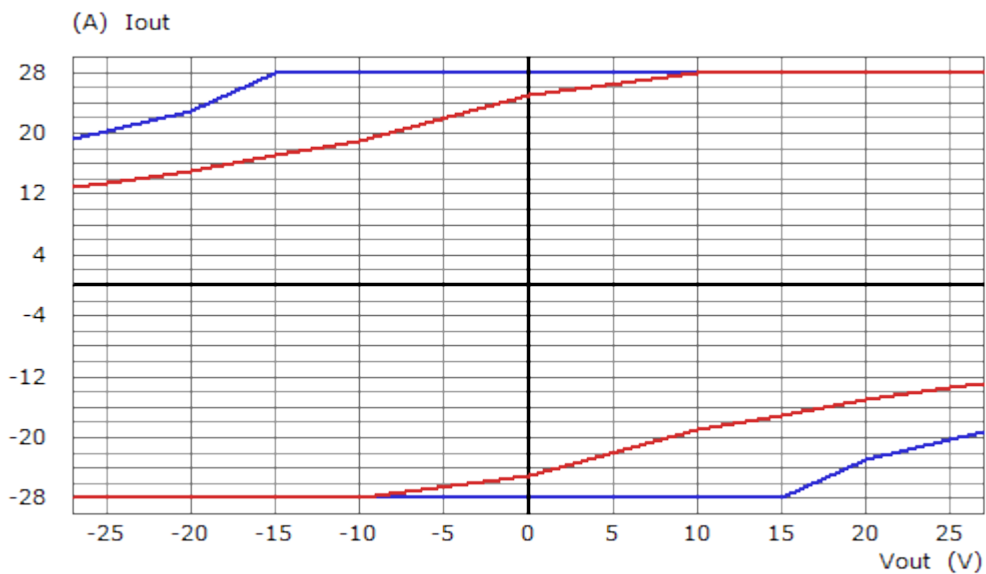

Output Current vs. Output Voltage (THD + N < 1%)
 Supply Voltage: Mid
 Blue: AC Limit
 Red: DC Limit

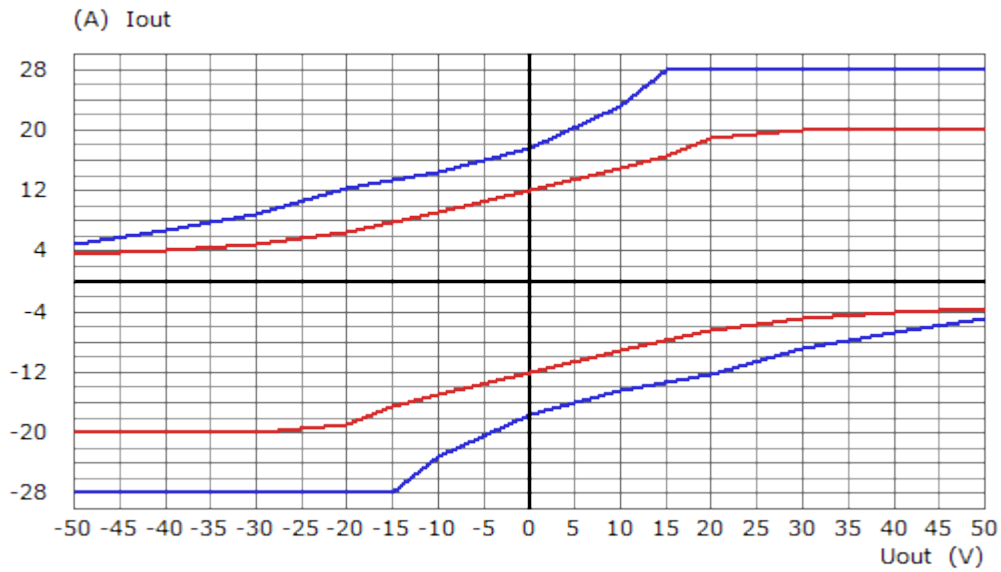

Output Current vs. Output Voltage (THD + N < 1%)
 Supply Voltage: High
 Blue: AC Limit
 Red: DC Limit

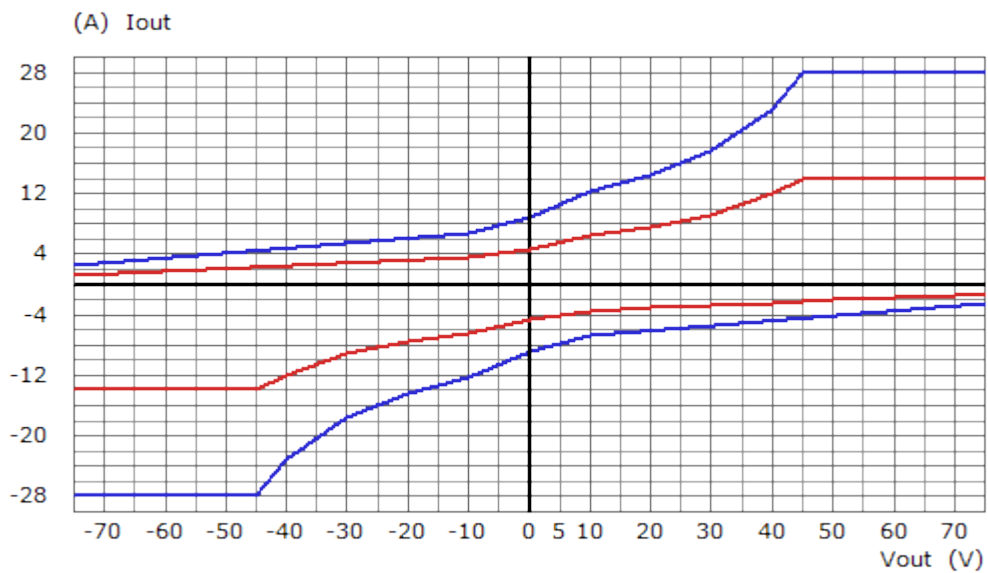

Square Wave at 100 kHz and 2,5 Ohm load

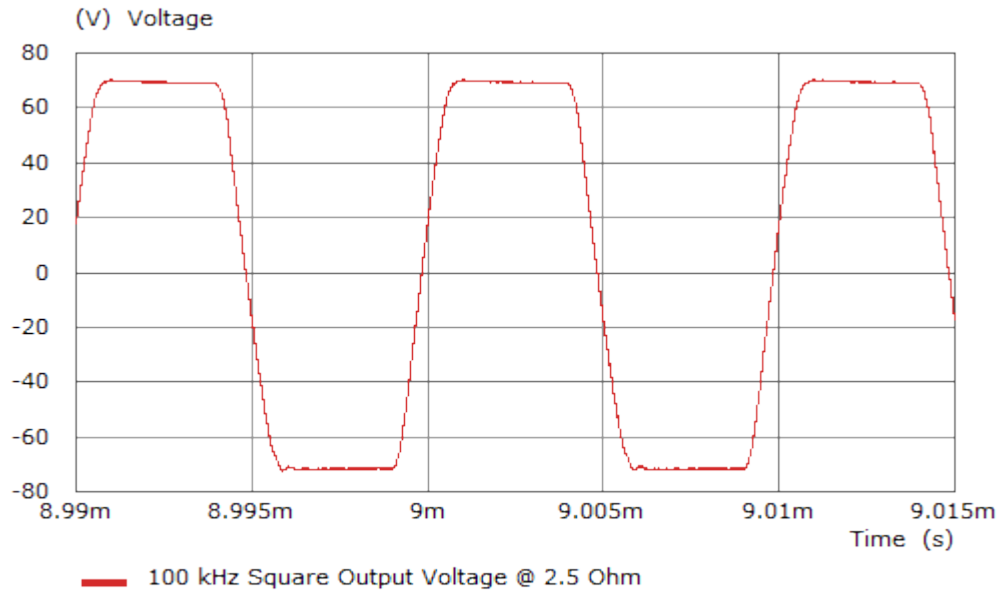

Power bandwidth at 3 Ohm load
(Input level normalised to max. output level at 30 kHz; THD+N < 1%)

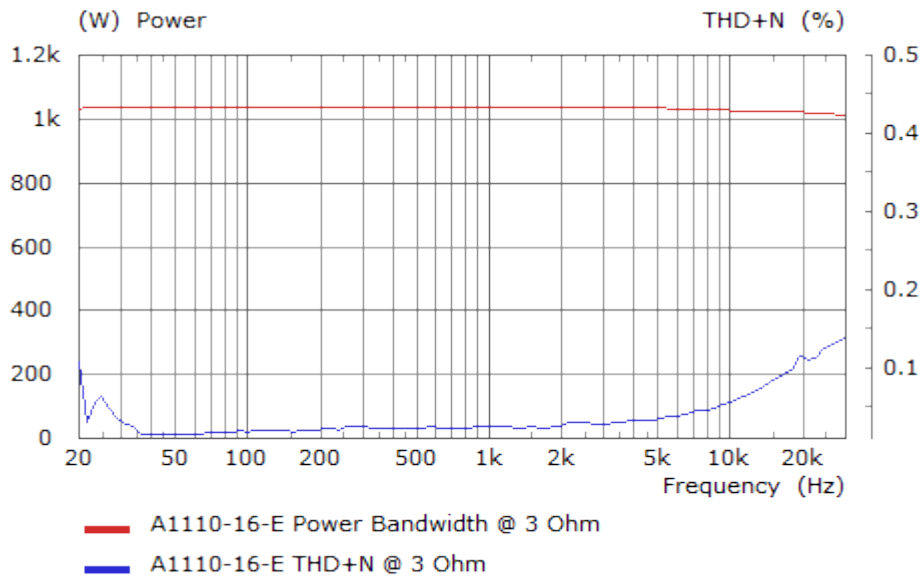

Power bandwidth at 3 Ohm load

(Input level normalised to max. output level at 200 kHz; THD+N < 1%)

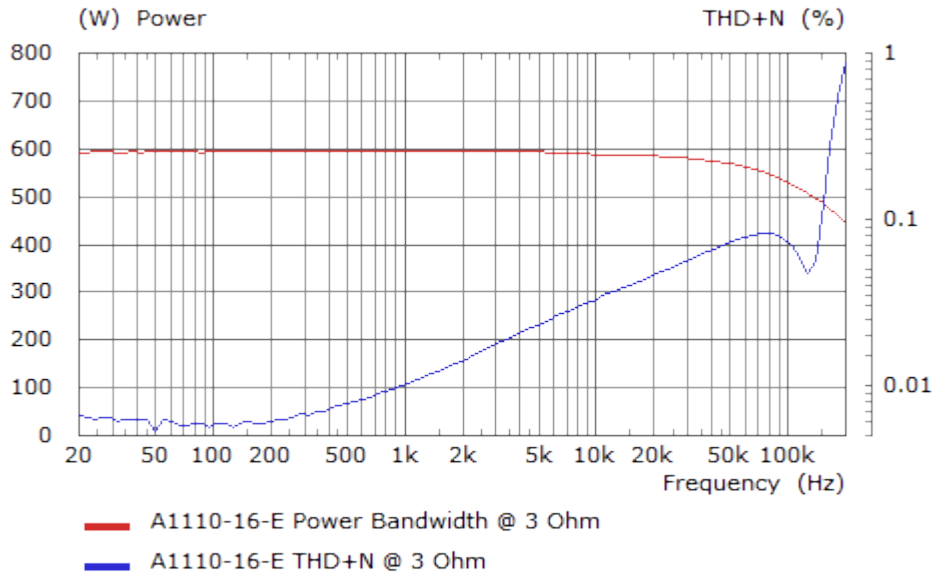

Power bandwidth at 8 Ohm load

(Input level normalised to max. output level at 100 kHz; THD+N < 1%)

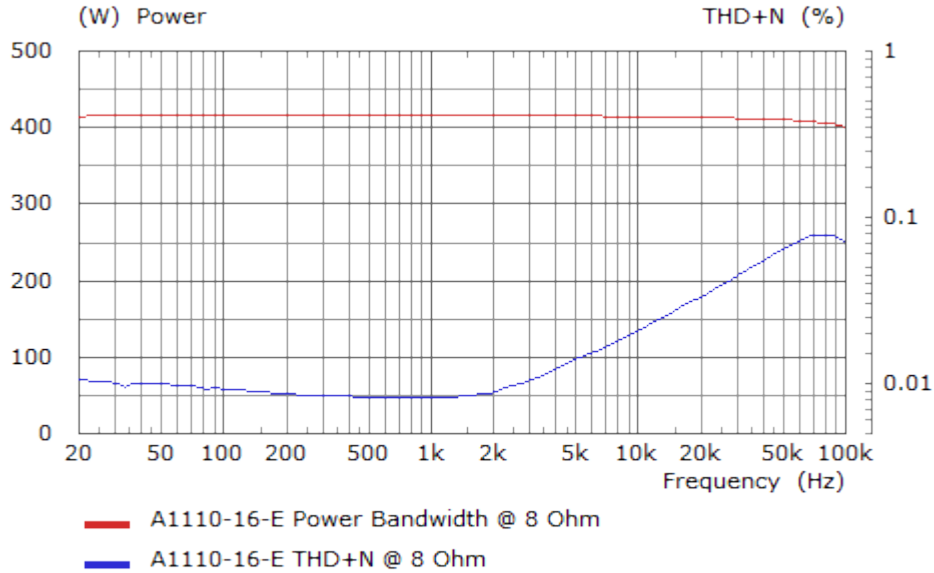

Pulse at 4 Ohm load

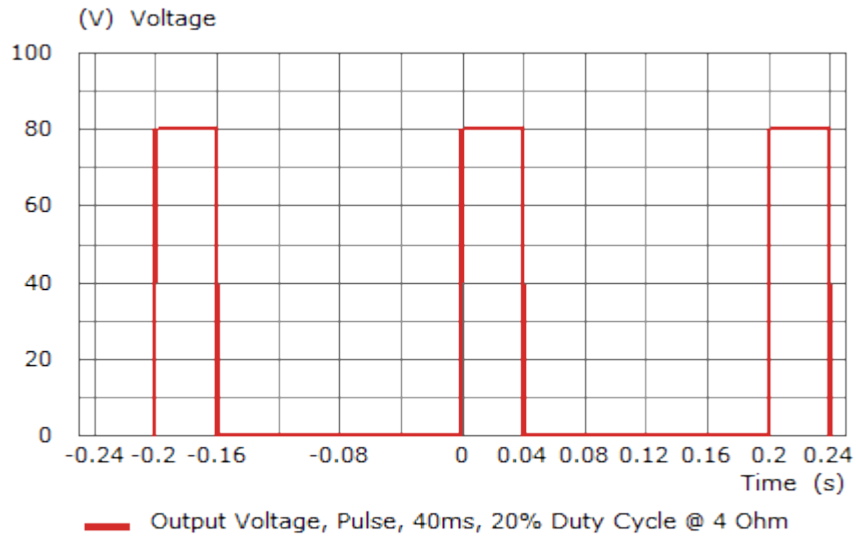

Output Impedance

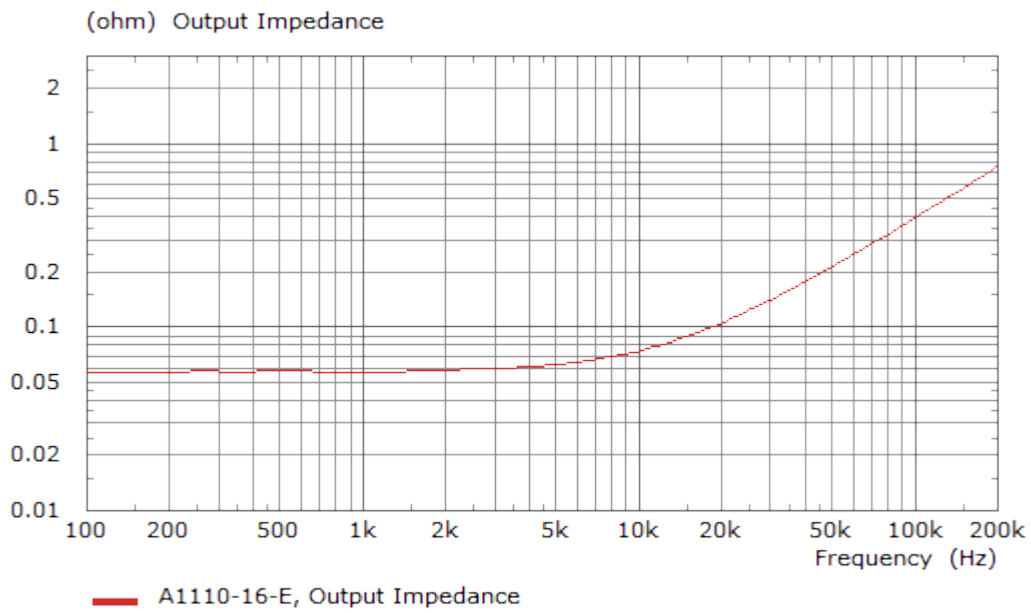

Block diagram A1110-16-E

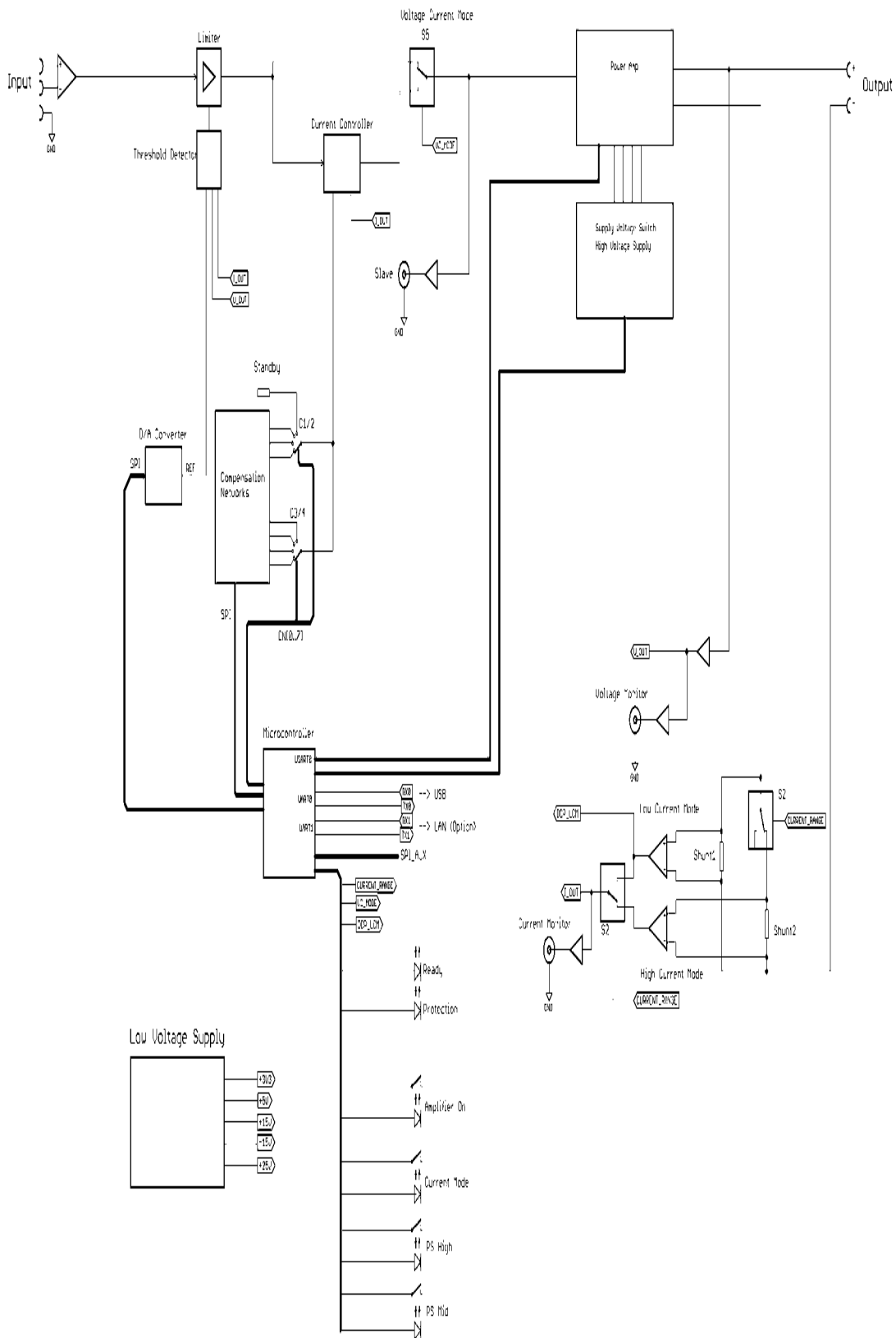

Ordering information

11100050	A1110-16-E; Precision power amplifier; incl. software
11101020	Option_02: Internal precision current measurement by means of high-performance current transformer 0-50A; Precision DC +/-0,1%; Bandwidth DC...>800kHz; Output BNC bush, galvanically isolated from the amplifier
11101030	Option_03: Ultra stable gain
11101040	Option_04: Function generator; DC, 0.05Hz - 300 kHz, sine, square, triangle
11101050	Option_05: Isolation amplifier for potential isolation of input and output
11101060	Option_06: Ethernet interface



Dr. Hubert GmbH
Universitätsstraße 142
44799 BOCHUM
GERMANY
Tel. +49 234 970569-0
Fax. +49 234 970569-29
sales@drhubert.de
www.drhubert.de